

## PATENT ABSTRACTS OF JAPAN

(11)Publication number : **11-009574**

(43)Date of publication of application : **19.01.1999**

(51)Int.Cl.

A61B 5/11

(21)Application number : **09-166976** (71)Applicant : **MATSUSHITA ELECTRIC  
IND CO LTD**

(22)Date of filing : **24.06.1997** (72)Inventor : **HAMAZAKI SHOGO  
YOSHIMURA TETSUYA  
YOSHIZAWA MASABUMI**

### (54) EXERCISING FUNCTION INSPECTING INSTRUMENT

(57)Abstract:

**PROBLEM TO BE SOLVED:** To achieve an accurate inspection of exercising function such as balancing function.

**SOLUTION:** A trace graphic 2 for indicating a target of the center position of a load of a subject is scrolled vertically on a screen 3. The center position of the load of the subject is measured by a load center measuring means 4 to be displayed on the screen 3 as marker graphic 1 and moved in the direction vertical to the direction of scrolling the trace graphic 2 (horizontal direction of the screen). A computer 5 analyzes a relative positional relationship or the like of the marker graphic 1 and the trace graphic 2 to evaluate exercising functions. In this process, as the time during which the trace graphic moves being scrolled in the length between the upper end of the screen 3 and the marker graphic 1 is predictable for a person to be tested, the distance D1 is determined front the predictable time as specified to achieve an inspection with the predictable time correctly determined thereby enabling inspection of the correct exercising functions.

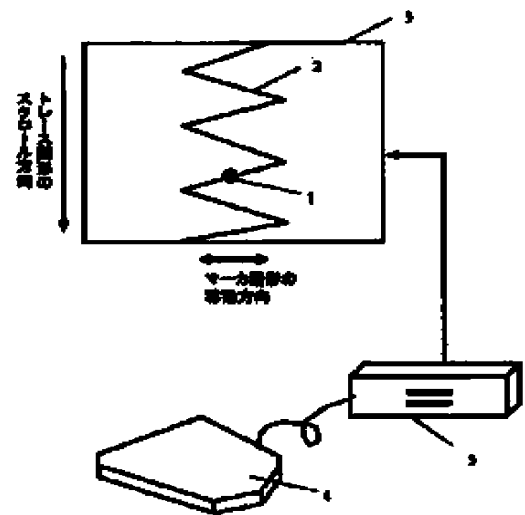



\* NOTICES \*

**JPO and INPIT are not responsible for any damages caused by the use of this translation.**

- 1.This document has been translated by computer. So the translation may not reflect the original precisely.
- 2.\*\*\*\* shows the word which can not be translated.
- 3.In the drawings, any words are not translated.

---

## CLAIMS

---

[Claim(s)]

[Claim 1]Have the following, and with time progress, said traced drawing form scrolls said screen top in length or a transverse direction, and moves, and said marker graphic is interlocked with a center position of a test subject's load, Move said screen top to a scroll direction and a perpendicular direction of said traced drawing type, and while said processing means generates a picture which contains said traced drawing form and said marker graphic at least, Motor function test equipment evaluating a test subject's motor function from at least one of relative location of a locus of said marker graphic, and said traced drawing type, and the loci of said marker graphic.

A screen which shows a test subject a picture.

A load-center measuring means which measures a center position of a test subject's load.

A marker graphic which expresses a center position of a test subject's load visually.

A processing means to estimate a test subject's motor function as a traced drawing form which expresses visually an orbit which should be pursued by said marker graphic while generating a picture and outputting to said screen.

[Claim 2]The motor function test equipment according to claim 1, wherein a traced drawing form is a figure expressed by two lines arranged at a constant interval.

[Claim 3]The motor function test equipment according to claim 1 or 2 being a waveform with regularity with a periodic traced drawing form.

[Claim 4]The motor function test equipment according to claim 3, wherein a traced drawing form is a triangular waveform.

[Claim 5]The motor function test equipment according to claim 3, wherein a traced drawing form is a sine wave form.

[Claim 6]The motor function test equipment according to claim 3, wherein a traced drawing form is a step waveform.

[Claim 7]The motor function test equipment according to claim 1 or 2, wherein a traced drawing form is a waveform with random amplitude.

[Claim 8]Motor function test equipment comprising:

A load-center measuring means which measures and outputs a center position of a test subject's load.

A marker graphic creating means which determines geometric information on said marker graphic as marker graphic information, and outputs it from a center position of load which made a marker graphic a figure which expresses a center position of a test subject's load visually, and was measured by said load-center measuring means.

A traced drawing form creating means which uses as a traced drawing form a figure which considers time progress, changes geometrically and directs a target of a center position of load to a test subject visually, determines geometric information on said traced drawing form as traced drawing form information, and outputs it.

A picture generation means which generates and outputs image data which drew a traced drawing form and a marker graphic at least from traced drawing form information on said traced drawing form creating means, and marker graphic information on said marker graphic creating means, A recording device which records sequentially a displaying means which shows a test subject image data outputted from said picture generation means, and said traced drawing form information and said marker graphic information, and evaluation methods which evaluate a test subject's motor function from record of said recording device.

[Claim 9]Time for a test subject to be able to predict change of a target of a center position of load beforehand is made into time which can be predicted, A time input means which inputs said time which can be predicted and which can be predicted is added, The motor function test equipment according to claim 8, wherein a marker graphic creating means is what determines and outputs marker graphic information from time which was inputted by said time input means which

can be predicted, and which can be predicted, and a load-center position measured by a load-center measuring means.

[Claim 10]A time input means as which a test subject makes time which can be predicted time to be able to predict change of a target of a center position of load beforehand, and inputs said time which can be predicted and which can be predicted, The motor function test equipment according to claim 8 adding an image processing means which inputs time of said time input means which can be predicted which can be predicted, and image data of a picture generation means, carries out concealment processing of said a part of image data according to said time which can be predicted, and is outputted to a displaying means.

[Claim 11]Evaluation methods The amount of gaps of a temporal response of a locus of a marker graphic, a locus of a marker graphic, and a traced drawing form, The motor function test equipment according to claim 8, 9, or 10 replacing by locus evaluation methods which evaluate a test subject's motor function from one that it is few, among the peak magnitude of a marker graphic locus.

[Claim 12]The motor function test equipment according to any one of claims 8 to 11 being what determines and outputs traced drawing form information by using as a traced drawing form a waveform which a traced drawing form creating means can express with a periodic function.

[Claim 13]The motor function test equipment according to claim 12, wherein a traced drawing form creating means is what determines and outputs traced drawing form information by using a triangular waveform as a traced drawing form.

[Claim 14]The motor function test equipment according to claim 12, wherein a traced drawing form creating means is what determines and outputs traced drawing form information by using a sine wave form as a traced drawing form.

[Claim 15]The motor function test equipment according to claim 12, wherein a traced drawing form creating means is what determines and outputs traced drawing form information by using a step waveform as a traced drawing form.

[Claim 16]The motor function test equipment according to any one of claims 8 to 11 being what determines and outputs traced drawing form information by using as a traced drawing form a waveform in which a traced drawing form creating means has random amplitude.

---

[Translation done.]

\* NOTICES \*

**JPO and INPIT are not responsible for any damages caused by the use of this translation.**

- 1.This document has been translated by computer. So the translation may not reflect the original precisely.
- 2.\*\*\*\* shows the word which can not be translated.
- 3.In the drawings, any words are not translated.

---

## **DETAILED DESCRIPTION**

---

[Detailed Description of the Invention]

[0001]

[Field of the Invention]In this invention, in accordance with the directions displayed on the display, a test subject moves the body, moves in the center of gravity, and analyzes the process.

Therefore, it is related with the equipment which inspects motor functions, such as a balance function.

[0002]

[Description of the Prior Art]In recent years, the patient who has a certain handicap in various motor functions including a balance function by various causes, such as an increase in population of the elderly people by arrival of an aging society, an increase in the hemiplegia patient by the cerebrovascular disease, and an increase in the dyskinesia patient by a traffic accident, is increasing.

[0003]Exact diagnosis of a patient's motor function is important for the therapy of such condition, and development of the test equipment for it is pressing need.

[0004]As a method of inspecting a motor function, directions of a posture change are given to a test subject with an image, and how to analyze the process of a posture change can be considered.

[0005]When a test subject generally changes a posture according to directions by vision, it is said that processing of a following series is performed. That is, the given directions are checked by the eye and it transmits to a brain (central nerves), a motion of parts of the body is adjusted by the central nerves, parts of

the body are ordered, by a group of muscles, parts of the body drive and the posture of the whole body is changed.

[0006]After directions are given by how to give directions with an image here, and vision before a test subject completes change of a posture, a relation with required time (henceforth, posture change time) is considered.

[0007]It is thought the case (for example, directions which determined the direction which topples the body by the random numbers) where a test subject gives only the posture of the next moment in a situation [ \*\*\*\*\* / completely ] that total of the processing time of a series of the processing of each of the above-mentioned "the eye (visual system) => brain (central nervous system) => group of muscles (drive system)" serves as posture change time.

[0008]On the other hand, from the present a series of posture changes to the point to some extent by the case (for example, directions of moving to the left gradually after moving the body to the right) where a test subject is given beforehand. A central nervous system is enabled to predict a previous posture to some extent from the directions obtained by the visual system, and it is thought that posture change time differs as compared with the above-mentioned directions [ \*\*\*\*\* ] (it becomes short).

[0009]That is, a difference will come out at a test subject's actual posture change time depending on how to give directions in consideration of the degree which can be predicted whether to give "directions which can be predicted", to give "directions [ \*\*\*\*\* ]", or to give further "directions which can be predicted how much."

[0010]It is expected that this influences not only posture change time but the positioning accuracy of posture regulation.

[0011]Thus, in the inspection of an athletic ability, the inspection after clarifying the degree which can be predicted as mentioned above is called for.

[0012]As equipment which has a function of a dynamic balance test while showing a picture conventionally, there is "weight shift training device" indicated to JP,H5-137759,A.

[0013]The above-mentioned conventional example is explained referring to Drawings below. Drawing 28 is a block diagram of conventional motor function test equipment.

[0014]The floor line where a test subject rides 11 in drawing 28, the driving means to which 12 carries out an inclination and movement of the floor line 11, A load-center detection means by which 13 detects the load center of the test

subject on the floor line 11, The target displaying means which displays the load-center position from which 14 becomes a target within the floor line 11, While 15 detects and displays the relative position gap with the target position displayed by the load center and the target displaying means 13 of the test subject detected by the load-center detection means 13, The feedback means which displays the locus of a target and the locus of a load center on the same screen, and 16 are control means to which a target is moved.

[0015]Drawing 29 is a screen constitution figure explaining the situation of the load-center pursuit in conventional motor function test equipment.

[0016]As for the target which 21 shows a target load-center position, the load-center mark 22 indicates a test subject's load-center position to be, and 23, in drawing 29, the locus of the target 21 and 24 are the loci of a load-center mark.

[0017]Next, the processing outline of conventional motor function test equipment is explained. A test subject stands straight to the floor line 11 in a standing position. The load-center detection means 13 is built into the floor line 11, and measures a test subject's load center.

[0018]The target displaying means 14 and the feedback means 15 are installed in the position which a test subject can see, and the screen shown in drawing 29 is displayed.

[0019]The floor line 11 can perform the inclination and horizontal migration of front and rear, right and left with the drive 12. The target 21 is movable at the rate of a request according to the course defined beforehand by the control means 16.

[0020]The floor line 11 and the target 21 are controlled according to a predetermined program of instruction, and a test subject moves in the center of gravity on the shaking floor line 11, moves the load-center mark 22, and carries out load-center pursuit training by pursuing the target 21.

[0021]After training, it is analyzing the rate of time the load-center mark 22 having caught the target 21, etc., and a test subject's athletic ability is evaluated.

[0022]

[Problem to be solved by the invention]However, in the above composition, since the orbit which a target moves simultaneously with a target is displayed and it is pointing to the target of the load-center position to the test subject, "directions which can be predicted" will have been given to the test subject, but. It had the problem that it was not clear how much it can predict to the point in time, and an exact inspection could not be conducted.



[0023]This invention solves an aforementioned problem. The purpose is to show a test subject with the presenting method which considered the degree which inputted beforehand the center position and target of a test subject's measured load, and which can be predicted, and to realize a high-precision motor function test.

[0024]

[Means for solving problem]In order to solve the above-mentioned problem the motor function test equipment of this invention, The screen which shows [ 1st ] a test subject a picture, and the load-center measuring means which measures the center position of a test subject's load, The marker graphic which expresses the center position of a test subject's load visually, and the traced drawing form which expresses visually the orbit which should be pursued by said marker graphic, It has a processing means to evaluate a test subject's motor function while generating a picture and outputting to said screen, With time progress, said traced drawing form scrolls said screen top in length or a transverse direction, and moves, and said marker graphic is interlocked with the center position of a test subject's load, Move said screen top to the scroll direction and perpendicular direction of said traced drawing type, and while said processing means generates the picture which contains said traced drawing form and said marker graphic at least, It has the composition of evaluating a test subject's motor function from at least one of the relative location of the locus of said marker graphic, and said traced drawing type, and the loci of said marker graphic.

[0025]It is having used the traced drawing form as the figure expressed by two lines arranged at the constant interval in said 1st means the 2nd.

[0026]It is having made the traced drawing form into the waveform with periodic regularity in said 1st or 2nd means the 3rd.

[0027]It is having made the traced drawing form into the triangular waveform in said 3rd means the 4th.

[0028]It is having used the traced drawing form as the sine wave form in said 3rd means the 5th.

[0029]It is having made the traced drawing form into the step waveform in said 3rd means the 6th.

[0030]It is having made the traced drawing form into the waveform with random amplitude in said 1st or 2nd means the 7th.

[0031]The load-center measuring means which measures and outputs [ 8th ] the

center position of a test subject's load, The marker graphic creating means which determines the geometric information on said marker graphic as marker graphic information, and outputs it from the center position of the load which made the marker graphic the figure which expresses the center position of a test subject's load visually, and was measured by said load-center measuring means, The traced drawing form creating means which uses as a traced drawing form the figure which considers time progress, changes geometrically and directs the target of the center position of load to a test subject visually, determines the geometric information on said traced drawing form as traced drawing form information, and outputs it, The picture generation means which generates and outputs the image data in which if small drew the traced drawing form and the marker graphic from the traced drawing form information on said traced drawing form creating means, and the marker graphic information on said marker graphic creating means, It has a recording device which records sequentially the displaying means which shows a test subject the image data outputted from said picture generation means, and said traced drawing form information and said marker graphic information, evaluation methods which evaluate a test subject's motor function from record of said recording device, and the composition of having provided \*\*.

[0032]Time for a test subject to be able to predict change of the target of the center position of load beforehand in said 8th means to the 9th is made into the time which can be predicted, It is having presupposed that the time input means which inputs said time which can be predicted and which can be predicted is added, and a marker graphic creating means determines and outputs marker graphic information from the time which was inputted by said time input means which can be predicted and which can be predicted, and the load-center position measured by the load-center measuring means.

[0033]The time input means which makes the time which can be predicted time for a test subject to be able to predict change of the target of the center position of load beforehand in said 8th means, and inputs into the 10th said time which can be predicted and which can be predicted, It has composition which added the image processing means which inputs the time of said time input means which can be predicted which can be predicted, and the image data of a picture generation means, carries out concealment processing of said a part of image data according to said time which can be predicted, and is outputted to a displaying means.

[0034]To the 11th, evaluation methods in said 8th, 9th, and 10th means The

temporal response of the locus of a marker graphic, It has composition replaced by the locus evaluation methods which evaluate a test subject's motor function from one that it is few, among the amount of gaps of the locus of a marker graphic, and a traced drawing form, and the peak magnitude of a marker graphic locus.

[0035]It is having presupposed that a traced drawing form creating means determines and outputs traced drawing form information to the 12th in said 8th, 9th, 10th, and 11th means by using as a traced drawing form the waveform which can be expressed with a periodic function.

[0036]It is having presupposed that a traced drawing form creating means determines and outputs traced drawing form information to the 13th by using a triangular waveform as a traced drawing form in said 12th means.

[0037]It is having presupposed that a traced drawing form creating means determines and outputs traced drawing form information to the 14th by using a sine wave form as a traced drawing form in said 12th means.

[0038]It is having presupposed that a traced drawing form creating means determines and outputs traced drawing form information to the 15th by using a step waveform as a traced drawing form in said 12th means.

[0039]It is having presupposed that traced drawing form information is determined and outputted to the 16th in said 8th, 9th, 10th, and 11th means by using as a traced drawing form a waveform in which a traced drawing form creating means has random amplitude.

[0040]

[Mode for carrying out the invention]

(Embodiment 1) The following is explained about motor function test equipment in the 1st embodiment of this invention, referring to Drawings.

[0041]Drawing 1 is a figure of an equipment configuration of motor function test equipment in the 1st embodiment of this invention, and screen constitution.

[0042]The marker graphic 1 indicates the center position of a test subject's load to be in drawing 1, the traced drawing form which is the targets which move and pursue the marker graphic 1 when a test subject sways an upper body and 2 moves the center position of load, The screen where 3 shows a test subject a picture, the center-of-gravity agitation meter in which 4 measures a test subject's load center, and 5 are computers which control the whole equipment and process data.

[0043]Drawing 2 is a hardware organization figure of the motor function test

equipment in the 1st embodiment of this invention.

[0044]The chair in which 201 was fixed to center-of-gravity agitation 4 [ a total of ] for a test subject to take a seating position in drawing 2, The display which 202 is provided with Screen 3 and displays a picture and a character, the regulation stand where 203 adjusts the height position of the display 202, An interfacing unit changed into the form which 211 incorporates data from center-of-gravity agitation 4 [ a total of ], and can be processed by computer 5, The keyboard with which 212 receives coded data, text, etc. from a user, The Video RAM which holds temporarily the information which displays 213 on the display 202, Auxiliary storage units, such as a hard disk in which 214 saves a program, data, etc., 215 reads a program and data from the auxiliary storage unit 214, and holds them temporarily, or, The main memory unit which holds temporarily the data read from the keyboard 212 or the interface board 211, and 216 with each command which constitutes the program currently held at the main memory unit 215. Process four operations, a logical operation, etc. to data, or the central processing unit which controls operation of the computer 5 whole, and 217 The interface board 211, the keyboard 212, Video RAM 213, the auxiliary storage unit 214, the main memory unit 215, It is a bus which connects the central processing unit 216, and data and the program between each equipment can be transmitted and received through this bus by control from the central processing unit 216.

[0045]Drawing 7 is an explanatory view of a screen display of the motor function test equipment in the 1st embodiment of this invention.

[0046]In Screen 3 of drawing 7, marker graphic 1 and traced drawing form 2 is displayed, and only traced drawing form 2 scrolls smoothly down from a top.

[0047]In Screen 3 of drawing 7, time for a traced drawing form to scroll the distance D1 of the upper bed of a screen and the marker graphic 1, and move turns into a test subject's time which can be predicted.

[0048]The following is an operation outline of the motor function test equipment in the 1st embodiment. As shown in drawing 2, the display 202 is put on the regulation stand 203, and it adjusts so that Screen 3 may become the height of a test subject's eyes. The chair 201 is put on [ a total of four ] center-of-gravity agitation, and it arranges so that a test subject may sit on the transverse plane of the display 202.

[0049]A test subject puts a leg on center-of-gravity agitation 4 [ a total of ], he sits on the chair 201 so that the center position of load may be in agreement with a total of four centers like the center of gravity, and he looks at the front display

202. It is being firmly fixed to center-of-gravity agitation 4 [ a total of ], and since it is low-mass enough, the chair 201 can also disregard the inertia, and it can measure a test subject's load center correctly. Although a test subject's centroid position is correctly orientated on three-dimensional space, in this example, the centroid position projected on center-of-gravity agitation a total of four floor lines is measured as a load center.

[0050]First, it inputs from the keyboard 211 by making information required for inspections, such as inspection time, forecast time, and a traced drawing form, into a verification condition.

[0051]If a verification condition is inputted, the central processing unit 216 will read a program and data required for an inspection from the auxiliary storage unit 214, will store them in the main memory unit 215, and will start a program.

[0052]The central processing unit 216 takes the lead, and is performed, and marker graphic 1 and traced drawing form 2 displays this program on Screen 3 of the display 202 via Video RAM 213.

[0053]A traced drawing form scrolls Screen 3 of the display 202 down from a top with time progress.

[0054]A motion of a test subject's upper body is measured by center-of-gravity agitation 4 [ a total of ] as a center position of load, is further downloaded to the computer 5 with the interfacing unit 211, and is displayed by the program as a motion of the longitudinal direction (the scroll direction and perpendicular direction of a traced drawing form) of Screen 3 of the marker graphic 1.

[0055]The position information on marker graphic 1 and traced drawing form 2 is sequentially saved as a recorder file at the auxiliary storage unit 214.

[0056]It repeats until inspection time ends these operations. Traced drawing form 2 [ that is, ] of the triangular wave which turns Screen 3 of the display 202 to down from a top, and scrolls smoothly with time progress, A test subject will perform operation pursued by the marker graphic 1 which is interlocked with movement of an upper body and moves to the longitudinal direction (the scroll direction and perpendicular direction of traced drawing form 2) of a screen fixed time.

[0057]Drawing 3 is a display example of the inspection result of a motor function. A recorder file is read from the auxiliary storage unit 214, and after an inspection is completed, by analyzing the peak magnitude of the locus of the marker graphic 1, etc., a test subject's motor function is inspected, and as shown in drawing 3, a result is displayed on Screen 3 of the display 202.

[0058]Next, the block configuration of the motor function test equipment in the 1st embodiment is explained. Drawing 4 is a block diagram of the motor function test equipment in this example.

[0059]The load-center measuring means which 101 measures the center position of a test subject's load, and is outputted in drawing 4, The traced drawing form creating means in which 102 generates continuously geometric information for traced drawing form 2 to scroll Screen 3 with time progress as traced drawing form information, The time input means which 103 makes the time which can be predicted the length of time for a test subject to be able to predict change of a load center beforehand, and specifies the time which can be predicted and which can be predicted, and 105 The center position of the load of the load-center measuring means 101, The marker graphic creating means which outputs the geometric information on the marker graphic 1 as marker graphic information from the time of the time input means 103 which can be predicted which can be predicted, 106 from the traced drawing form information on the traced drawing form creating means 102, and the marker graphic information on the marker graphic creating means 105. The picture generation means which generates and outputs the image data which drew marker graphic 1 and traced drawing form 2 to a desired position, The displaying means which shows a test subject the image data to which 107 was outputted from the picture generation means 106, The recording device on which 108 records sequentially marker graphic information and traced drawing form information, and 109 evaluate a test subject's motor function from the amount of gaps of the locus of the marker graphic 1, and traced drawing form 2, and the peak magnitude of the locus of the marker graphic 1, They are locus evaluation methods displayed as an inspection result.

[0060]In the 1st embodiment, center-of-gravity agitation 4 [ a total of ] which measures a test subject's load center is used as an example of concrete equipment of the load-center measuring means 101.

[0061]In the 1st embodiment, the keyboard 212 is used as an example of concrete equipment of the time input means 103 which can be predicted.

[0062]In the 1st embodiment, the computer 5 is used as an example of concrete equipment of the traced drawing form creating means 102, the marker graphic creating means 105, the picture generation means 106, the recording device 108, and the locus evaluation methods 109.

[0063]In the 1st embodiment, the display 202 is used as an example of concrete equipment of the displaying means 107.

[0064]Next, the coordinate system used with the motor function test equipment in the 1st embodiment is explained using figures.

[0065]Drawing 5 is an explanatory view of a measurement coordinate system [ in / embodiment / 1st / a center-of-gravity agitation meter ].

[0066]In drawing 5, center-of-gravity agitation a total of four centers are made into the starting point O, and X and the Y-axis which are shown in drawing 5 are provided, respectively.

[0067]Drawing 6 is an explanatory view of a screen coordinate system [ in / embodiment / 1st / the display 202 ].

[0068]It is \*\*\*\*, respectively about X and the Y-axis which make the point at the upper left of Screen 3 the starting point O, and are shown in drawing 6 in drawing 6.

[0069]In the motor function test equipment in the 1st embodiment. as the upper limit of the time base range of the centroid position of center-of-gravity agitation a total of four test subjects -- X of a measurement coordinate system, and each direction of Y -- variable grab\_x [mm] and variable grab\_y [mm] being used, and as a value of a test subject's measured centroid position, X of a measurement coordinate system, and each direction of Y -- variable pos\_x [mm] and variable pos\_y [mm] are used.

[0070]the motor function test equipment in the 1st embodiment -- as the size of Screen 3 of the display 202 -- X of a screen coordinate system, and each direction of Y -- variable disp\_x [mm] and variable disp\_y [mm] are used.

[0071]In the motor function test equipment in the 1st embodiment, as inspection time and forecast time, the variable ttime [sec] and the variable ptime [sec] are used, respectively, and the variable W, variable A [mm], and the variable T [sec] are used as the wave-like kind, amplitude, and cycle of a traced drawing form, respectively.

[0072]In the motor function test equipment in the 1st embodiment, the variable time [sec] is used as lapsed time from an inspection start, the variable c is used as a record counter, and the variable i and the variable t are used as a temporary variable for loop processings.

[0073]In the motor function test equipment in the 1st embodiment, the variable D1 [mm] is used as the distance D1 of the upper bed of Screen 3, and the marker graphic 1.

[0074]In the motor function test equipment in the 1st embodiment, positional variable mdata\_x [mm] of a marker graphic, mdata\_y [mm], and radius variable

mdata\_r [mm] of a marker graphic are used in X of a screen coordinate system, and the direction of Y as marker graphic information.

[0075]In the motor function test equipment in the 1st embodiment, X of a screen coordinate system and the array variable (tdata\_x, tdata\_y) of the point which constitutes a traced drawing form in the direction of Y are used as traced drawing form information, and a unit is set to [mm].

[0076]In the motor function test equipment in the 1st embodiment, lapsed time array variable rec\_time, traced drawing form array variable rec\_tx, and marker graphic array variable rec\_mx are used as an object for record.

[0077]In the motor function test equipment in the 1st embodiment. as the maximum centroid movement width -- each right and left -- variable BR [mm] and the variable BL [mm] being used, and as a gap average with a traced drawing form and a marker graphic, Variable ST [mm], variable SR [mm], and variable SL [mm] are used about the whole, the right, and the left, respectively, and variable BB is used as a temporary variable.

[0078]Here, the variable and array variable which are used in the 1st embodiment are stored in the main memory unit 215, the storing region of an array variable shall be large enough, and the required number only of elements shall use it.

[0079]Detailed operation of the motor function test equipment in the 1st embodiment is explained using a flow chart.

[0080]Drawing 14 to drawing 24 is a flow chart of detailed operation of the motor function test equipment in the 1st embodiment.

[0081]Drawing 14 is the 1st whole embodiment flow chart. First, it explains from the preparation procedure of an inspection.

[0082]The limit-of-measurement value of the load-center measuring means 101 and the screen size of the displaying means 107 are set as each variable, The time which can be predicted is inputted by the time input means 103 which can be predicted, the waveform kind of a traced drawing form, amplitude, a cycle, and inspection time are also inputted by the keyboard 212, and it sets them as the traced drawing form creating means 102, and initializes the lapsed time and the counter for record of an inspection, and preparation completes it (Steps S1-S3 of drawing 1).

[0083]Here, traced drawing form 2 shall scroll Screen 3 at the rate of 10 [mm/sec].

[0084]Inspection routine is explained below. First, lapsed time and a record counter are updated (step S4 of drawing 14).



[0085]Next, a test subject's load center is measured by the load-center measuring means 101 (Step S5 of drawing 14).

[0086]By the marker graphic creating means 105, the distance D1 is calculated based on (several 1), The marker position information in a screen coordinate system is calculated from a load-center position and forecast time, and marker graphic information is generated (step S6-1 of Steps S6 and S7 of drawing 14, and drawing 15 - S6-2, step S7-1 of drawing 16 - S7-2).

[0087]

[Mathematical formula 1]

$$D1 = ptime / 60 \times disp\_y$$

[0088]600 dot data which constitute a traced drawing form are calculated from a verification condition and lapsed time, such as a wave-like kind and amplitude, by the traced drawing form creating means 102 (step S8-3-1 - S8-3-4 of step S8-1 - S8-of Step [ of drawing 14 ] S8, and drawing 17 3, and drawing 18).

[0089]At this time, it calculates about the trace waveform of a triangular wave with the flow chart shown in drawing 18 (step S8-3-1 of drawing 18 - S8-3-4).

[0090]About the traced drawing form of a sine wave, it calculates with the flow chart shown in drawing 19 (step S8-3-11 of drawing 19 - S8-3-12).

[0091]About the traced drawing form of a step wave, it calculates with the flow chart shown in drawing 20 (step S8-3-21 of drawing 20 - S8-3-24).

[0092]About the traced drawing form of a random wave, it calculates with the flow chart shown in drawing 21 (step S8-3-31 of drawing 21 - S8-3-32).

[0093]Next, a picture is generated from traced drawing form information and marker graphic information by the picture generation means 106 (step S9-1 of step S9 of drawing 14, and drawing 22 - S9-2), and it displays on the displaying means 107 (Step S10 of drawing 14).

[0094]By the recording device 108, lapsed time, a marker graphic position, and a traced drawing form position are made into a group, and are recorded (step S11-1 of Step [ of drawing 14 ] S11, and drawing 23 - S11-2).

[0095]And a series of above operations (step S4-S11 of drawing 14) are repeated until it judges whether inspection time was completed (Step S12 of drawing 14) and inspection time is completed.

[0096]Finally, after inspection time is completed, the locus evaluation methods 109 read record from the recording device 108, analyze it about the maximum centroid movement width etc., and display an inspection result (step S13-1 of

Step S13 of drawing 14, and drawing 24 - S13-12).

[0097](Embodiment 2) The following is explained about motor function test equipment in the 2nd embodiment of this invention, referring to Drawings.

[0098]Hardware organization in the 2nd embodiment of this invention is the same as that of the 1st embodiment, and omits explanation.

[0099]Drawing 8 is an explanatory view of a screen display in the 2nd embodiment of this invention. In screen constitution of the 2nd embodiment shown in drawing 8, there is the picture concealment field 6 for hiding the upper part of a traced drawing form which scrolls to down [ of Screen 3 ] in addition to a screen display of the 1st embodiment shown in drawing 7 from a test subject.

[0100]In Screen 3, time for a traced drawing form to scroll the distance D2 of the bottom of the picture concealment field 6 and the marker graphic 1, and move turns into a test subject's time which can be predicted.

[0101]Next, a block configuration of motor function test equipment in the 2nd embodiment is explained. Drawing 9 is a block configuration of motor function test equipment in the 2nd embodiment.

[0102]A load-center measuring means which 101 measures a center position of a test subject's load, and is outputted in drawing 9, A traced drawing form creating means in which 102 generates continuously geometric information for traced drawing form 2 to scroll Screen 3 with time progress as traced drawing form information, 103 makes time which can be predicted the length of time for a test subject to be able to predict change of a load center beforehand, A time input means which specifies time which can be predicted and which can be predicted, and 105 from a center position of load of the load-center measuring means 101, A marker graphic creating means which outputs geometric information on the marker graphic 1 as marker graphic information, 106 from traced drawing form information on the traced drawing form creating means 102, and marker graphic information on the marker graphic creating means 105. A picture generation means which generates and outputs image data which drew marker graphic 1 and traced drawing form 2 to a desired position, and 104 consider time of the time input means 103 which can be predicted which can be predicted to image data outputted from the picture generation means 106, An image processing means which conceals and outputs a part of picture, a displaying means which shows a test subject image data to which 107 was outputted from the image processing means 104, a recording device on which 108 records sequentially marker graphic information and traced drawing form information, 109 is locus evaluation methods

which evaluate a test subject's motor function from the amount of gaps of a locus of the marker graphic 1, and traced drawing form 2, and the peak magnitude of a locus of the marker graphic 1, and are displayed as an inspection result.

[0103] Suppose that it is the same as that of the 1st embodiment in the 2nd embodiment as an example of concrete equipment of the load-center measuring means 101, the time input means 103 which can be predicted, the traced drawing form creating means 102, the marker graphic creating means 105, the picture generation means 106, the recording device 108, and the locus evaluation methods 109.

[0104] In the 2nd embodiment, the computer 5 is used as an example of concrete equipment of the image processing means 104.

[0105] A coordinate system used with motor function test equipment in the 2nd embodiment is the same as a coordinate system in the 1st embodiment described by drawing 5 and drawing 6.

[0106] In addition to a variable used in the 1st embodiment, the following variables are used for a variable used in the 2nd embodiment.

[0107] That is, a representative point of the picture concealment field 6 is made into a top left point (hx0, hy0) and a lower right point (hx1, hy1), and variable hx0, hy0, hx1, and hy1 are used, respectively.

[0108] In Screen 3, the variable D2 is used as the distance D2 of the bottom of a picture concealment field, and a marker graphic.

[0109] Here, all the variables used in the 2nd embodiment are stored in the main memory unit 215 like the 1st embodiment.

[0110] Detailed operation of the motor function test equipment in the 2nd embodiment is explained using a flow chart focusing on a different portion from the 1st embodiment.

[0111] Drawing 25 to drawing 27 is a flow chart of the detailed operation in the 2nd embodiment. Drawing 25 is a flow chart of the 2nd whole embodiment.

[0112] In drawing 25, Step T1 - Step T5 are the same as the tetraethylpyrophosphate S1 of drawing 14 in the 1st embodiment - Step S5.

[0113] Unlike the 1st embodiment, in the marker graphic creating means 105, a marker's position is determined regardless of forecast time (step T6-1 of Step T6 of drawing 25, and drawing 26 - T6-2).

[0114] In drawing 25, Step T7 - Step T9 are the same as that of Step S7 of drawing 14 in the 1st embodiment - step S9.

[0115] In the image processing means 104, a field which should calculate the

distance D2 using (several 2), and should be further concealed from forecast time inputted by the forecast time input means 103 is calculated, and the field is concealed (step T21-1 of Step [ of drawing 25 ] T21, and drawing 27 - T21-3).

[0116]

[Mathematical formula 2]

$$D2 = \text{ptime} / 60 \times \text{disp\_y}$$

[0117]Step T10 in drawing 25 - Step T13 are the same as Step S10 of drawing 14 in the 1st embodiment - Step S12.

[0118]As mentioned above, while showing traced drawing form 2 which scrolls in the 1st and 2nd embodiments, By calculating the distance D1 and D2 in consideration of forecast time, and determining position mdata\_y of the lengthwise direction of the marker graphic 1 in Screen 3, the inspection which set correctly the time which can be predicted can be conducted and the inspection of an exact motor function is attained.

[0119]In the 1st and 2nd embodiments, while showing traced drawing form 2 which scrolls, directions of the load-center position to a test subject can carry out correctly intelligibly by moving the marker graphic 1 to a longitudinal direction in a test subject's load-center position.

[0120]In the 1st and 2nd embodiments, a sine wave form, a step waveform, and a random waveform besides a triangular wave can be used as a traced drawing form by specifying the kind W at Step S2 or Step T2.

[0121]The example of a screen display and effect at the time of using these waveforms are explained using figures. By using a triangular wave as a traced drawing form, directions and an exact inspection of a uniform velocity posture change are especially attained in the operation which followed the longitudinal direction.

[0122]Drawing 10 is a figure showing the example of a screen display at the time of using the sine wave form of trigonometric functions as a traced drawing form.

[0123]By using a sine wave form as a traced drawing form, as shown in drawing 10, directions and an exact inspection of the posture change which includes reasonable smooth inversion operation especially are attained in the operation which followed the longitudinal direction.

[0124]Drawing 11 is a figure showing an example of a screen display at the time of using a step waveform as a traced drawing form.

[0125]By using a step waveform shown in drawing 11 as a traced drawing form,

directions and an exact inspection of a rapid posture change and posture maintenance are especially attained in operation which followed a longitudinal direction.

[0126]Drawing 12 is a figure showing an example of a screen display when amplitude uses as a traced drawing form a random waveform which changes at random.

[0127]By using a random waveform shown in drawing 12 as a traced drawing form, directions and an exact inspection of a variegated posture change are especially attained in operation which followed a longitudinal direction.

[0128]Drawing 13 is an example of a screen display at the time of using as a traced drawing form the waveform which expressed the triangular waveform by two lines which maintain a constant interval.

[0129]In the operation which followed the longitudinal direction, directions and an exact inspection of the posture change of maintaining a posture especially at a certain within the limits are attained by making a waveform from the 1st and 2nd embodiments by two lines which maintain a constant interval as a traced drawing form. It is also possible to constitute the sine wave form, step waveform, and random waveform other than a waveform which constituted the triangular waveform from double lines like drawing 13 from double lines.

[0130]Drawing 30 is a figure showing the example of a screen display for inspecting the motor function of a test subject's cross direction.

[0131]Although inspected about a test subject's upper body swaying carrying out in the 1st and 2nd embodiments, As shown in drawing 30, the motor function test of the cross direction a test subject's upper body also becomes possible by scrolling traced drawing form 2 toward the left from the screen right, and transposing change of the cross direction a test subject's load-center position to movement of the screen sliding direction of traced drawing form 2.

[0132]A standing position inspection is also possible by desorption of the chair 201 being attained and it removing the chair 201 in the 1st and 2nd embodiments, and a test subject's standing straight and inspecting on [ a total of four ] center-of-gravity agitation.

[0133]In the 1st and 2nd embodiments, by changing the size of a marker graphic, and the line width of a traced drawing form, it becomes possible to double with a test subject's eyesight and inspection environment, and a more exact motor function test becomes possible.

[0134]

[Effect of the Invention]While showing the traced drawing form which scrolls as mentioned above according to this invention, by arranging a marker graphic on a screen in consideration of forecast time, it becomes possible to conduct the inspection which set correctly the time which can be predicted, and the inspection of an exact motor function is attained.

[0135]While showing the traced drawing form which scrolls, directions of the load-center position to a test subject can carry out correctly intelligibly by moving a marker graphic to a scroll direction and a perpendicular direction in a test subject's load-center position.

[0136]In the operation which followed the cross direction/longitudinal direction, the inspection of the exact motor function accompanied by a uniform velocity posture change is especially attained by using a triangular wave as a traced drawing form.

[0137]In the operation which followed the cross direction/longitudinal direction, the inspection of the exact motor function accompanied by the posture change which includes reasonable smooth inversion operation especially is attained by using the sine wave of trigonometric functions as a traced drawing form.

[0138]In the operation which followed the cross direction/longitudinal direction, the inspection of the exact motor function accompanied by a rapid posture change and posture maintenance is especially attained by using a step waveform as a traced drawing form.

[0139]In the operation which followed the cross direction/longitudinal direction, the inspection of the exact motor function accompanied by a variegated posture change is especially attained by using a \*\* [ which changes at random ] random [ amplitude ] waveform as a traced drawing form.

[0140]In the operation which followed the cross direction/longitudinal direction, the inspection of the exact motor function accompanied by the posture change of maintaining a posture especially at a certain within the limits is attained by making a waveform by two lines which maintain a constant interval as a traced drawing form.

---

[Translation done.]

\* NOTICES \*

**JPO and INPIT are not responsible for any damages caused by the use of this translation.**

- 1.This document has been translated by computer. So the translation may not reflect the original precisely.
- 2.\*\*\*\* shows the word which can not be translated.
- 3.In the drawings, any words are not translated.

---

## **DESCRIPTION OF DRAWINGS**

---

[Brief Description of the Drawings]

[Drawing 1]The figure showing the equipment configuration and screen constitution of motor function test equipment in the 1st embodiment of this invention

[Drawing 2]The hardware organization figure of the motor function test equipment in the 1st and 2nd embodiments of this invention

[Drawing 3]The figure showing the example of a screen display of the inspection result of the motor function test equipment in the 1st and 2nd embodiments of this invention

[Drawing 4]The block diagram of the motor function test equipment in the 1st embodiment of this invention

[Drawing 5]The explanatory view of the measurement coordinate system in the center-of-gravity agitation meter of the motor function test equipment in the 1st and 2nd embodiments of this invention

[Drawing 6]The explanatory view of the display coordinate system in the screen of the motor function test equipment in the 1st and 2nd embodiments of this invention

[Drawing 7]The explanatory view of a screen display of the motor function test equipment in the 1st embodiment of this invention

[Drawing 8]The explanatory view of a screen display of the motor function test equipment in the 2nd embodiment of this invention

[Drawing 9]The block diagram of the motor function test equipment in the 2nd embodiment of this invention

[Drawing 10]The explanatory view of the example of a screen display which used

the sine wave form of the motor function test equipment in the 1st and 2nd embodiments of this invention for the traced drawing form

[Drawing 11]The explanatory view of the example of a screen display which used the step waveform of the motor function test equipment in the 1st and 2nd embodiments of this invention for the traced drawing form

[Drawing 12]The explanatory view of the example of a screen display which used the random waveform of the motor function test equipment in the 1st and 2nd embodiments of this invention for the traced drawing form

[Drawing 13]The explanatory view of the example of a screen display which used the double-lines triangular waveform of the motor function test equipment in the 1st and 2nd embodiments of this invention for the traced drawing form

[Drawing 14]The whole motor function test equipment flow chart in the 1st embodiment of this invention

[Drawing 15]The flow chart of the marker position decision processing of the motor function test equipment in the 1st embodiment of this invention

[Drawing 16]The flow chart of the marker graphic information generation processing of the motor function test equipment in the embodiment of the 1st and 2nd \*\* of this invention

[Drawing 17]The flow chart of the traced drawing form information generation processing of the motor function test equipment in the embodiment of the 1st and 2nd \*\* of this invention

[Drawing 18]The flow chart of the triangular-wave computation of the motor function test equipment in the embodiment of the 1st and 2nd \*\* of this invention

[Drawing 19]The flow chart of the sine wave computation of the motor function test equipment in the embodiment of the 1st and 2nd \*\* of this invention

[Drawing 20]The flow chart of the step wave computation of the motor function test equipment in the embodiment of the 1st and 2nd \*\* of this invention

[Drawing 21]The flow chart of the random wave computation of the motor function test equipment in the embodiment of the 1st and 2nd \*\* of this invention

[Drawing 22]The flow chart of image generation processing of the motor function test equipment in the embodiment of the 1st and 2nd \*\* of this invention

[Drawing 23]The flow chart of the recording processing of the motor function test equipment in the embodiment of the 1st and 2nd \*\* of this invention

[Drawing 24]The flow chart of locus evaluation processing of the motor function



test equipment in the embodiment of the 1st and 2nd \*\* of this invention

[Drawing 25]The whole motor function test equipment flow chart in the 2nd embodiment of this invention

[Drawing 26]The flow chart of the marker position decision processing of the motor function test equipment in the 2nd embodiment of this invention

[Drawing 27]The flow chart of picture concealment processing of the motor function test equipment in the 2nd embodiment of this invention

[Drawing 28]The block diagram of conventional motor function test equipment

[Drawing 29]The screen constitution figure explaining the situation of load-center pursuit of conventional motor function test equipment

[Drawing 30]The explanatory view of a screen display of the motor function test equipment in the 1st and 2nd embodiments of this invention

[Explanations of letters or numerals]

1 Marker graphic

2 Traced drawing form

3 Screen

4 Center-of-gravity agitation meter

5 Computer

6 Picture concealment field

11 Floor line

12 Driving means

13 Load-center detection means

14 Target displaying means

15 Feedback means

16 Control means

21 Target

22 Load-center mark

23 The locus of a target

24 The locus of a load-center mark

101 Load-center measuring means

102 Traced drawing form creating means

103 The time input means which can be predicted

104 Image processing means

105 Marker graphic creating means

106 Picture generation means

107 Displaying means

108 Recording device  
109 Locus evaluation methods  
201 Chair  
202 Display  
203 Regulation stand  
211 Interfacing unit  
212 Keyboard  
213 Video RAM  
214 Auxiliary storage unit  
215 Main memory unit  
216 Central processing unit  
217 Bus

---

[Translation done.]

## \* NOTICES \*

**JPO and INPIT are not responsible for any damages caused by the use of this translation.**

- 1.This document has been translated by computer. So the translation may not reflect the original precisely.
- 2.\*\*\*\* shows the word which can not be translated.
- 3.In the drawings, any words are not translated.

---

**CORRECTION OR AMENDMENT**

---

[Kind of official gazette]Printing of amendment by regulation of Patent Law Article 17 of 2

[Section Type] The 2nd Type of the part I gate

[Publication date]Heisei 17(2005) March 17 (2005.3.17)

[Publication No.]JP,11-9574,A

[Date of Publication]Heisei 11(1999) January 19 (1999.1.19)

[Application number]Japanese Patent Application No. 9-166976

[The 7th edition of International Patent Classification]

A61B 5/11

[FI]

A61B 5/10 310 B

[Written Amendment]

[Filing date]Heisei 16(2004) April 26 (2004.4.26)

[Amendment 1]

[Document to be Amended]Description

[Item(s) to be Amended]Claims

[Method of Amendment]Change

[The contents of amendment]

[Claim(s)]

[Claim 1]

A screen which shows a test subject a picture,

A load-center measuring means which measures a center position of a test

subject's load,

A marker graphic which expresses a center position of a test subject's load visually,

A traced drawing form which expresses visually an orbit which should be pursued by said marker graphic,

While generating a picture containing a marker graphic and a traced drawing form and outputting to said screen, it has a processing means to evaluate a test subject's motor function,

Motor function test equipment, wherein said traced drawing form scrolls said screen top with time progress and said marker graphic moves on said screen by change of a load-center position.

[Claim 2]

A test subject makes time which can be predicted time to be able to predict change of a traced drawing form beforehand,

A time input means which inputs said time which can be predicted and which can be predicted is added,

The motor function test equipment according to claim 1, wherein a traced drawing form scrolls a screen top on conditions determined from time progress and time which can be predicted.

[Claim 3]

A test subject makes time which can be predicted time to be able to predict change of a traced drawing form beforehand,

A time input means which inputs said time which can be predicted and which can be predicted is added,

The motor function test equipment according to claim 1, wherein a marker graphic moves in a screen top on conditions determined from a load-center position and time which can be predicted.

[Claim 4]

The motor function test equipment according to claim 1, 2, or 3, wherein a marker graphic moves in the direction vertical to a scroll direction of said traced drawing type.

[Claim 5]

A marker graphic which expresses visually a center position of a screen which shows a test subject a picture, a load-center measuring means which measures a center position a test subject's load's, and a test subject's load, and a traced drawing form which expresses visually an orbit which should pursue by said

marker graphic,

While generating a picture and outputting to said screen, it has a processing means to evaluate a test subject's motor function,

With time progress, said traced drawing form scrolls said screen top in length or a transverse direction, and moves, and said marker graphic is interlocked with a center position of a test subject's load, Move said screen top to a scroll direction and a perpendicular direction of said traced drawing type, and while said processing means generates a picture which contains said traced drawing form and said marker graphic at least, Motor function test equipment evaluating a test subject's motor function from at least one of relative location of a locus of said marker graphic, and said traced drawing type, and the loci of said marker graphic.

[Claim 6]

The motor function test equipment according to any one of claims 1 to 5, wherein a traced drawing form is a figure expressed by two lines arranged at a constant interval.

[Claim 7]

The motor function test equipment according to any one of claims 1 to 6 being a waveform with regularity with a periodic traced drawing form.

[Claim 8]

The motor function test equipment according to claim 7, wherein a traced drawing form is a triangular waveform.

[Claim 9]

The motor function test equipment according to claim 7, wherein a traced drawing form is a sine wave form.

[Claim 10]

The motor function test equipment according to claim 7, wherein a traced drawing form is a step waveform.

[Claim 11]

The motor function test equipment according to any one of claims 1 to 6, wherein a traced drawing form is a waveform with random amplitude.

[Claim 12]

A load-center measuring means which measures and outputs a center position of a test subject's load,

A marker graphic creating means which determines geometric information on said marker graphic as marker graphic information, and outputs it from a center

position of load which made a marker graphic a figure which expresses a center position of a test subject's load visually, and was measured by said load-center measuring means,

A traced drawing form creating means which uses as a traced drawing form a figure which considers time progress, changes geometrically and directs a target of a center position of load to a test subject visually, determines geometric information on said traced drawing form as traced drawing form information, and outputs it,

A picture generation means which generates and outputs image data which drew a traced drawing form and a marker graphic at least from traced drawing form information on said traced drawing form creating means, and marker graphic information on said marker graphic creating means,

A displaying means which shows a test subject image data outputted from said picture generation means,

A recording device which records sequentially said traced drawing form information and said marker graphic information, and evaluation methods which evaluate a test subject's motor function from record of said recording device  
Providing motor function test equipment.

[Claim 13]

Time for a test subject to be able to predict change of a target of a center position of load beforehand is made into time which can be predicted, and a time input means which inputs said time which can be predicted and which can be predicted is added,

The motor function test equipment according to claim 12, wherein a marker graphic creating means is what determines and outputs marker graphic information from time which was inputted by said time input means which can be predicted, and which can be predicted, and a load-center position measured by a load-center measuring means.

[Claim 14]

A time input means as which a test subject makes time which can be predicted time to be able to predict change of a target of a center position of load beforehand, and inputs said time which can be predicted and which can be predicted, The motor function test equipment according to claim 12 adding an image processing means which inputs time of said time input means which can be predicted which can be predicted, and image data of a picture generation means, carries out concealment processing of said a part of image data according to said

time which can be predicted, and is outputted to a displaying means.

[Claim 15]

Evaluation methods,

The motor function test equipment according to claim 12, 13, or 14 replacing by locus evaluation methods which evaluate a test subject's motor function from one that it is few, among the amount of gaps of a temporal response of a locus of a marker graphic, a locus of a marker graphic, and a traced drawing form, and the peak magnitude of a marker graphic locus.

[Claim 16]

A traced drawing form creating means,

The motor function test equipment according to any one of claims 12 to 15 being what determines and outputs traced drawing form information by using as a traced drawing form a waveform which can be expressed with a periodic function.

[Claim 17]

A traced drawing form creating means,

The motor function test equipment according to claim 16 being what determines and outputs traced drawing form information by using a triangular waveform as a traced drawing form.

[Claim 18]

A traced drawing form creating means,

The motor function test equipment according to claim 16 being what determines and outputs traced drawing form information by using a sine wave form as a traced drawing form.

[Claim 19]

A traced drawing form creating means,

Traced drawing form information is determined and outputted by using a step waveform as a traced drawing form.

The motor function test equipment according to claim 16 characterized by things.

[Claim 20]

A traced drawing form creating means,

The motor function test equipment according to any one of claims 12 to 15 being what determines and outputs traced drawing form information by using a waveform with random amplitude as a traced drawing form.

---

[Translation done.]

(19) 日本国特許庁 (J P)

(12) 公開特許公報 (A)

(11) 特許出願公開番号

特開平11-9574

(43) 公開日 平成11年(1999) 1月19日

(51) Int.Cl.<sup>5</sup>

A 6 1 B 5/11

識別記号

F I

A 6 1 B 5/10

3 1 0 B

審査請求 未請求 請求項の数16 O L (全 20 頁)

(21) 出願番号

特願平9-166976

(22) 出願日

平成9年(1997) 6月24日

(71) 出願人

000005821

松下電器産業株式会社

大阪府門真市大字門真1006番地

(72) 発明者

濱崎 省吾

大阪府門真市大字門真1006番地

松下電器産業株式会社内

(72) 発明者

吉村 哲也

大阪府門真市大字門真1006番地

松下電器産業株式会社内

(72) 発明者

吉澤 正文

大阪府門真市大字門真1006番地

松下電器産業株式会社内

(74) 代理人

弁理士 滝本 智之 (外1名)

(54) 【発明の名称】

運動機能検査装置

(57)

y v æ  
 y ɛ ɔ t @ ¥ ^ fi @ ¥ 単  
 - ~ 節  
 y ɛ - d S 音  
 Ø g [ X } ` Q ~ ° R 運  
 d S " ɛ ɛ i S - - 走  
 ~ } [ J } ` P ~ ~ ° " 導  
 X N [ B ~ ~ " " 導  
 Ø B R s [ ^ T ^ } [ 導  
 . I ° u W " . " 導  
 - - A ° R a [ ~ 導1 g [ 導  
 X } ` " X N [ ~ 導  
 ¥ ~ ~ " % A w ɛ 導1 導  
 ɛ • Ø - ~ ɛ A ¥ " 導  
 s f † m " ^ fi @ ¥ 導

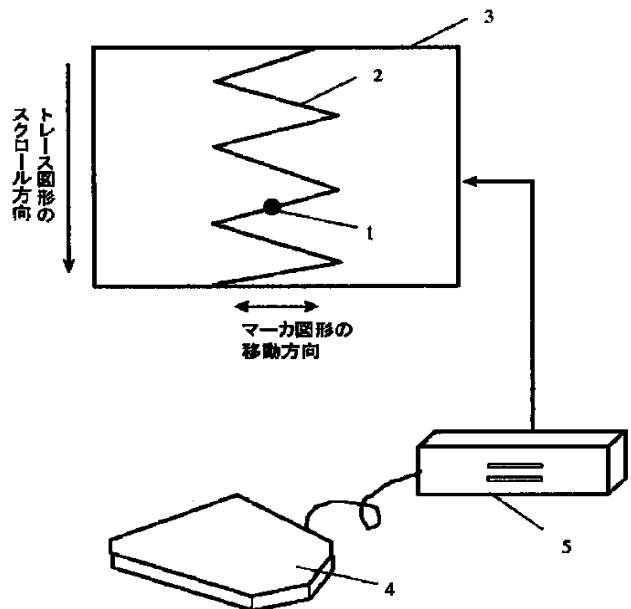



1					2										
y	˘	z	z		^	fi	@	¥	]	z	•	Ø	]	z	齒
Y	z	Pz	-		Y	z	Xz	-	"	d				S	齒
	d		S	°	Y	z	"	~	¥	"	Ø	¥	"	'	齒
)	[	J	)	'	Y	O	"	"	"	Ø	¥	"	'	齒	
˘	A		'	•	)	[	J	)	'	Ø	¥	"	'	齒	
	¶	<	O	L	S	°	u	"	'	¥	"	'	Ø	d	齒
@	¥	]	z	•	Ø	-	"	'	¥	"	•	Ø	z		齒
O	L	g	[	X	]	Y	z	O	"	~	¥	"	Ø		齒
"	i	B		X	N	[		~	¥	"	•	Ø	z		齒
-		d		S	°	Y	z	O	"	~	¥	"	Ø		齒
	[	X	)	'	X	N	[	X	)	'	¥	"	"	•	Ø
"	>	"	O	L	g	[	X	)	'	¥	"	"	L	i	¥
	O	~	O	L	g	[	X	)	'	f	[	^	"	O	L
)	[	J	)	'	O	~	>	"	"	f	[	^	€	B	¢
@	¥	]	z	•	¥	¥	¥	¥	¥	^	fi	@	¥	¥	¥
Y	z	Qz	g	[	X	)	'	"	A	€	€	Y	z		齒
æ	{	-	¥	>	¥	€	Ø	)	'	¥	¥	¥	¥	¥	¥
P	L		^	fi	¥					20				I	齒
Y	z	Rz	g	[	X	)	'	"	æ	齒	Y	z			齒
˘	-	Ø	-	"	¥	~	•	Ø	齒	Ø	O	X	]	z	齒
@	¥	¥							W	A	X	¥	"	P	O
Y	z	Sz	g	[	X	)	'	"	O	p	齒	Y	z		齒
¥	~	•	Ø	z	R	L	單		æ	I	"	-	¥	>	齒
Y	z	¥	g	[	X	)	'	"	T	C	齒	~	•	Ø	z
˘	¥	~	•	Ø	z	R	L	單	X	e	齒	u	B		齒
Y	z	Uz	g	[	X	)	'	"	X	e	齒	Y	z		齒
˘	¥	~	•	Ø	z	R	L	單	u	B		Y	z		齒
Y	z	Vz	g	[	X	)	'	"	30	齒	Y	z			齒
˘	-	Ø	-	"	¥	~	•	Ø	齒	Ø	O	X	]	z	齒
@	¥	¥							^	fi	@	¥	¥	¥	¥
Y	z	Wz	-		d		S	齒	Y	z					齒
•	Ø	d	S	基					T	C	g	~	g	[	X
˘	~	d	S	°	u		齒		L	o	"	•	Ø	-	齒
˘	~	A	O	L	d	S	"	L	齒	^	fi	@	單		
u	'	O	L	)	[	J	)	'	Y	z					齒
æ	~	~	L	o	"	•	Ø	齒	X	e	b	v	g	~	g
	o		i		%	w	I	齒	L	o	"	•	Ø	-	齒
W	A	o	I	-	'	w	齒	40	L	o	^	fi	@	單	
A	O	L	g	[	X	)	'	"	Y	z					齒
æ	~	~	L	o	"	•	Ø	齒	X	)	'	æ	W	P	P
O	L	g	[	X	)	'	¶	<	Ø	z		z		齒	
[	J	)	'	¶	<	L	i	}'	Y	>		z		齒	
˘	~	[	J	)	'	>	"	>	Y	O	O	B	z		齒
<	~	o	"	•	Ø	基			Y	>	O	B	z		齒
O	L	¶	<	L	i	'	o	"	Y	>	%	w	f		齒
æ	f	•	Ø	¥	基		æ	~	O	L	g	[	X	)	'
O	L	g	[	X	)	'	L	i	A	O					齒
O	L	^	•	Ø	L	^	L	i	50	¥					齒



5

Y O O Q z  
 Y { > . Ø ^ fi @ ¥ A , 彙  
 Ø æ f · S " L L i ~ A O 彙  
 I ¥ · } [ J } · g [ X - 彙  
 " o " · Ø f A O L g B 10  
 L i ° a J } O L g [ X } i " 彙  
 ) [ J } A O L > " > O ~ O 彙  
 O L } [ J } A O L } @ ¥ [ J } ] 彙  
 u W ~ J A O L ^ fi @ ¥ [ J } ] 彙  
 y O O Q T z Q A O L # 彙  
 X } ° - B U z R A O L 彙  
 y O O Q U z R A O L 彙  
 y O O Q V z S A O L 彙  
 y O O Q W z T g 彙  
 y O O Q X z U g 彙  
 y O O Q X e b v g 彙  
 y O O R O z V A O L 彙  
 y ~ A g [ X } W A - 彙  
 y O O R P z W A - 彙  
 ~ o " · Ø d S " L L } ' 彙  
 " L L i - " L æ % } i ~ d [ J A 彙  
 Ø } [ J } ' d g [ X } } u ~ 40  
 · Ø } ' æ g [ X } } A O [ X } } 彙  
 w I [ X } ' A g f [ ^ L i i ~ 彙  
 ~ A O æ f · Ø ¥ f ~ ' A I 彙  
 } [ J } L ^ - 彙

6

Y O O R Q z X A O L 彙  
 " O d ' ¥ " ' ¥ " L i ~ A O L 彙  
 ' ¥ " ' ¥ " L i ~ A O L 彙  
 S æ y O O R R z " P O A O L 彙  
 " " ¥ " ' ¥ " L i ~ A O L 彙  
 " ' ¥ " ' ¥ " L i ~ A O L 彙  
 " ' ¥ " ' ¥ " L i ~ A O L 彙  
 H ~ " ¥ f L i P P A O L 彙  
 Y O O R S z P P A O L 彙  
 [ J } ^ fi @ ¥ ] z · Ø 彙  
 < ~ " > B T z P Q A O L 彙  
 Y O O R T z P Q A O L 彙  
 P L i » L o " · 彙  
 y O O R U z < P R A O L 彙  
 g [ X } ' ¶ < æ P S A O L 彙  
 y O O R V z ¶ < L i " A T L 彙  
 [ X } ' ¶ < æ 彙  
 ~ g [ X } ' 彙  
 Ø B Y O O R W z P T A O L 彙  
 [ X } ' ¶ [ X } ' 彙  
 ~ g [ X } ' 彙  
 Ø B Y O O R X z P U A O L 彙  
 " U L i n ç g " · Ø 彙  
 æ y O O 彙  
 y > { ' P j " " A 彙  
 Ø ^ fi @ ¥ , u ' ç 彙  
 · B Ø S P z } P " { > 彙  
 Y O O S P z } P " { > 彙  
 @ ¥ O S Q z } P u ¥ < n ç ~ 彙  
 y O O f · } [ J } A Q " 彙





y O O W T z d S  
 d S " L • Ø i }  
 y O O W U z } [ J }  
 ^ ç ~ £ c P v z  
 ° W n n fl Ø }  
 } ` æ ¶ < • Ø i }  
 V C } P T X e b v r U  
 e b v r V ¥ P  
 y O O W z  
 y <sup>E</sup>

$$D1 = \text{ptime} / 60 \times \text{disp}_y$$

y O O W W z g [ X }  
 A U " ' ,  
 ¥ < • Ø U O O ' \_ æ  
 v r W C } P V X e b v  
 X e b v r W ¥ R ¥  
 y O O W X z - A O p  
 } P W f • t [ ` [  
 b v r W ¥ R ¥ P  
 y O O X O z % A T C  
 } P X f • t [ ` [  
 b v r W ¥ R ¥ P P  
 y O O X P z % A X e b  
 ~ } Q O f • t [ `   
 e b v r W ¥ R ¥ Q P  
 y O O X Q z % A \_  
 ~ } Q P f • t [ `   
 e b v r W ¥ R ¥ R P  
 y O O X R z A ¶  
 æ ~ } [ J } ` æ ~  
 e b v r X C } Q Q X e  
 ¥ f L i P O V ¥ f •  
 O j B  
 y O O X S z † A L ^  
 J } ` ° u ~ g [ X } `   
 i } P S X e b v r P P  
 P ` r P  
 y O O X T z » ~ A ,  
 f i } P S X e b v r  
 - A " a E A fi i  
 P j J<sup>E</sup>  
 y O O X U z - a A ,  
 L i P O X " L ^ L i P O  
 d S fi " ' ' ç ~  
 P S X e b v r P R C }  
 r P R ¥  
 y O O X V z i { `   
 { E n fl Ø ^ fi @ ¥  
 " "   
 y O O X W z { > Q

A ¥ < " A P { E ~  
 Ø B O X X z } W " { >   
 y O O X X z } W " { >   
 ¥ f " A } V f • P  
 < - " A } V f • P  
 ° R " B X N [

```

0, hy0, hx1, hy1      g p B
y O P O W z      % A      ° R B
"      ~ } [ J D2 ~      D2      g p B
y O P O X z - - - A Q
"      P      { A ~ fl l
Ø B
y O P P O z      Q      { A
      fi      ' ç ~ A P
      ~ A t      [ ~      [
y O P P P z } Q T '      }
      fi      t      [ ~      [ g
A S      t      [
y O P P Q z } Q T      □ ç
T ~ A P      { A      □ fl
b v r T ~
y O P P R z } [ J } ~ T
{ A ~      " L ¥ "      †
Ø i } Q T      X e b v s U
` s U ¥
y O P P S z } Q T      □ ç
X ~ A P      { A      □ fl
e b v r X ~
y O P P T z      ` H L i
i P O R -      "      % ¥ "
D2      v Z      A †      B      ç •
      B      ç • Ø i } Q T
e b v s Q P ¥ P
y O P B z
y      Ø

```

$$D2 = \text{ptime} / 60 \times \text{disp\_y}$$

y > ł ° z " a / 璣  
 • Ø g [ X } ` æ 璣  
 ¶ ~ ° } [ J } ` 璣  
 ¥ ‡ m " ^ fi @ ¥ 璣  
 ‡ m " ^ fi @ ¥ 璣  
 y O P R T z % A X N 璣  
 • Ø ~ ~ A ~ ... B f " 璣  
 N [ B S ° u w f " 璣  
 ~ " - B 璣  
 y O P R U z % A g [ 璣  
 Ø - ~ A ` Ł A O a B ^ 璣  
 ¢ ~ " ' ¥ 璣  
 , " ' ¥ 璣  
 y O P R V z % A g [ 璣  
 g g p • Ø - ~ Ł ‡ m " ^ 璣  
 % fi ~ X " / < ‡ m " ^ 璣  
 p n ~ X " / < ‡ m " ^ 璣  
 y O P R W z % A g [ 璣  
 p ¢ Ø - ~ A ` Ł A O a B ^ 璣  
 n ¢ ~ A ` } 璣  
 m " ^ fi @ ¥ 璣  
 y O P R X z % A g [ 璣  
 ~ >> • Ø • A - g ` 璣  
 ^ ¶ E B ‡ m " ^ fi @ 璣  
 ~ X " / ‡ m " ^ fi @ 璣  
 y O P S O z % A g [ 璣  
 æ { - % fi n ¢ ~ A 璣  
 ~ ¢ / p n ~ X " / ‡ m 璣  
 Ø B ° " 璣  
 y } P z { > P 璣  
 y } u ¥ < n ° ¥ 璣  
 u } Q z { > P n 璣  
 @ ¥ , u n 璣  
 y } R z { > P n 璣  
 @ ¥ , u , 璣  
 y } S z { > P 璣  
 u u 璣  
 y } T z { > P n 璣  
 @ ¥ , u d S fi h 璣  
 y } U z { > P n 璣  
 @ ¥ , u ° 璣  
 y } V z { > P 璣  
 u ° ¥ f 璣  
 y } W z { > Q 璣  
 u ° ¥ f 璣  
 y } X z { > Q 璣  
 u u 璣

y ) P O z { > P n 璣  
 fi @ ¥ , u T C g 璣  
 ° ¥ f E 璣



P ) [ √  
 Q g [ X  
 R °  
 S d S 𐄂  
 I R s ↑  
 U B  
 P P °  
 P Q fi 𐄂  
 P R d S 𐄂  
 P S ^ [ Q b 𐄂  
 P T t B [ h 𐄂  
 P U S 𐄂  
 Q P ^ [ 𐄂  
 Q Q d S  
 Q R ^ [ Q b 𐄂  
 Q S d S } 𐄂  
 P O P d S 𐄂  
 P Q g [ X }

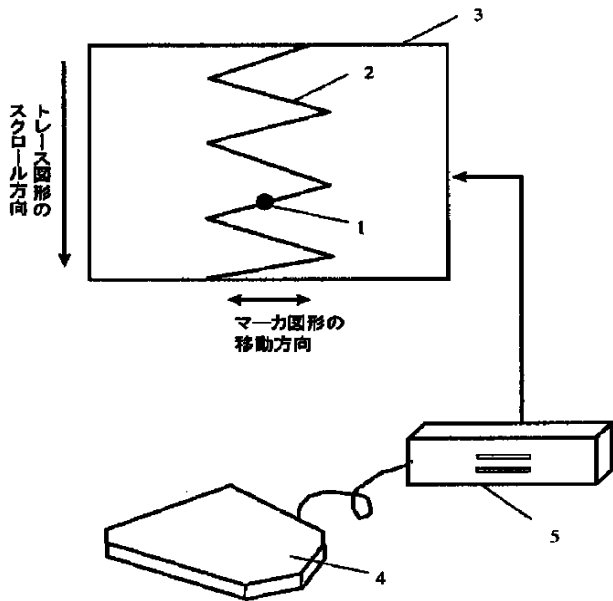

軌跡の評価結果:

最大重心移動幅  
 右 59.0 mm  
 左 43.5 mm

トレース図形とマーカ図形のずれ平均  
 全体 2.756 mm  
 右 2.85 mm  
 左 2.66 mm

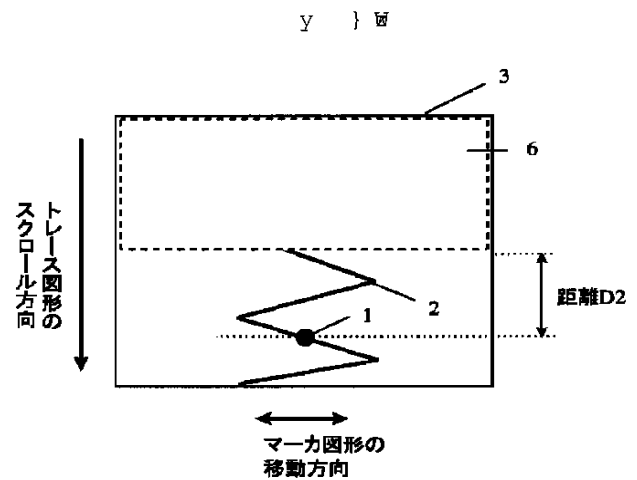
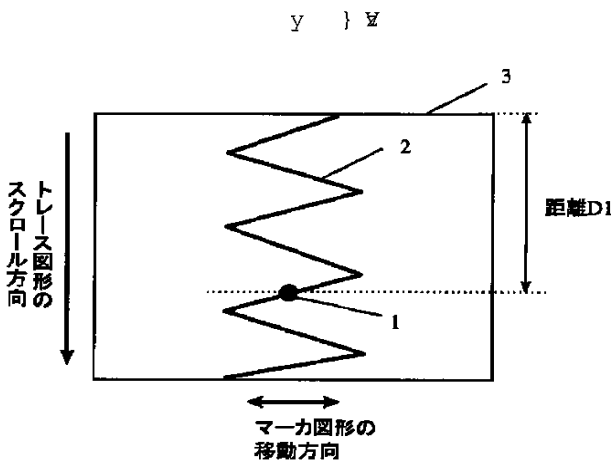
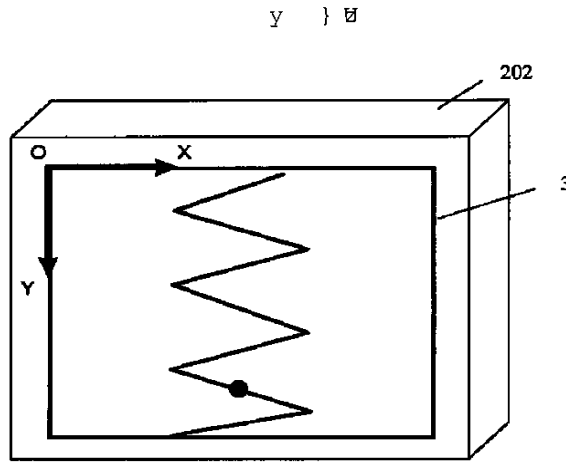
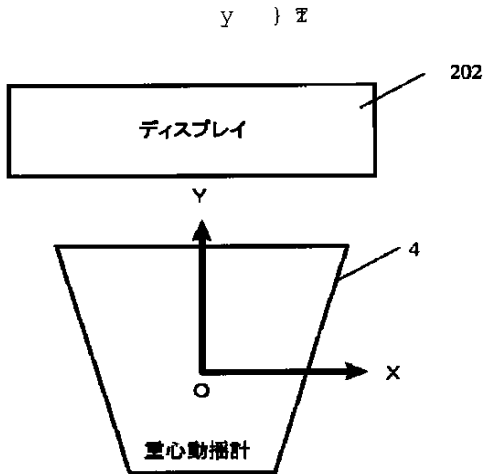
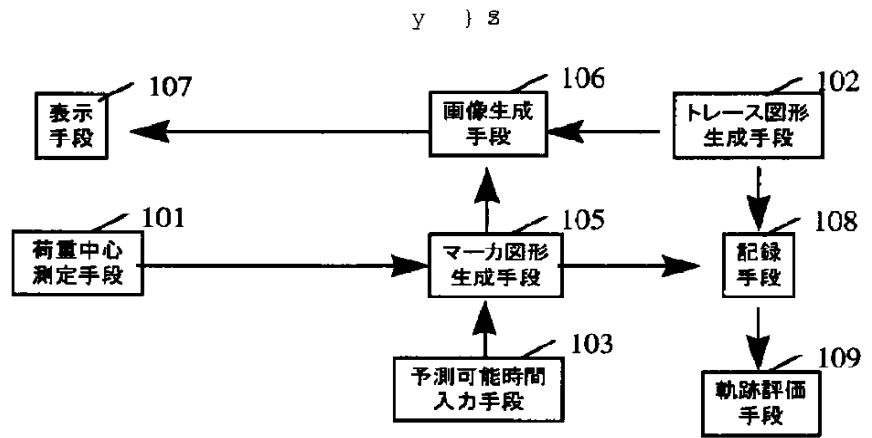

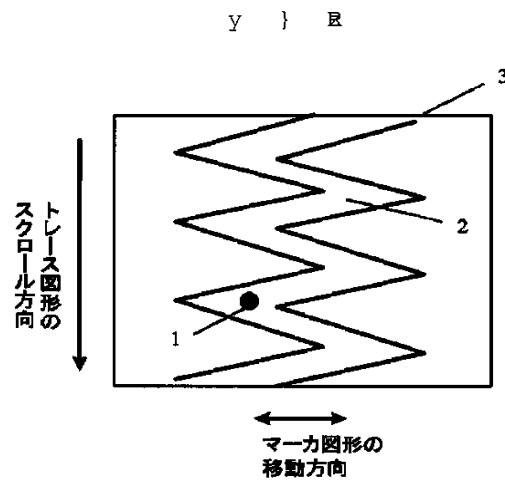
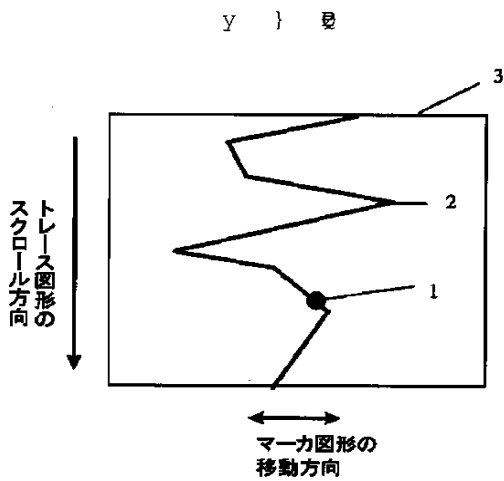
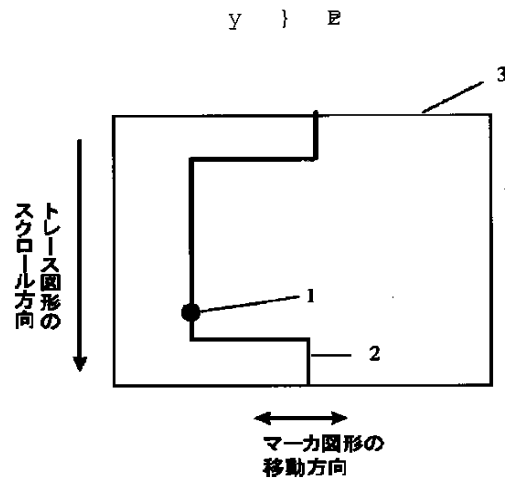
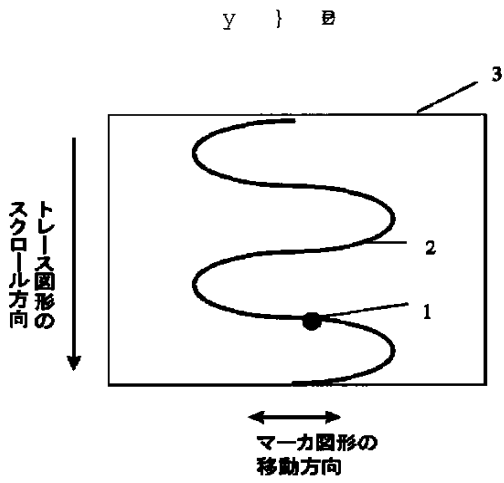
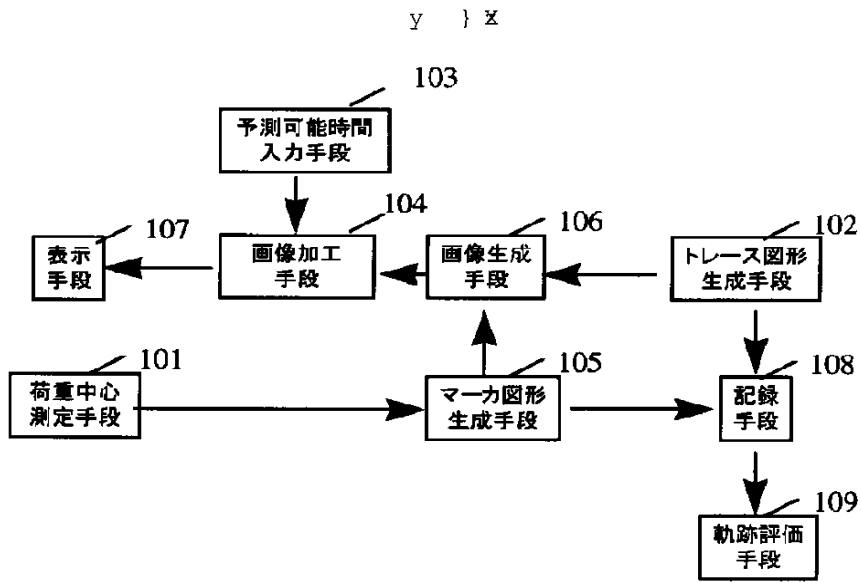

y } E

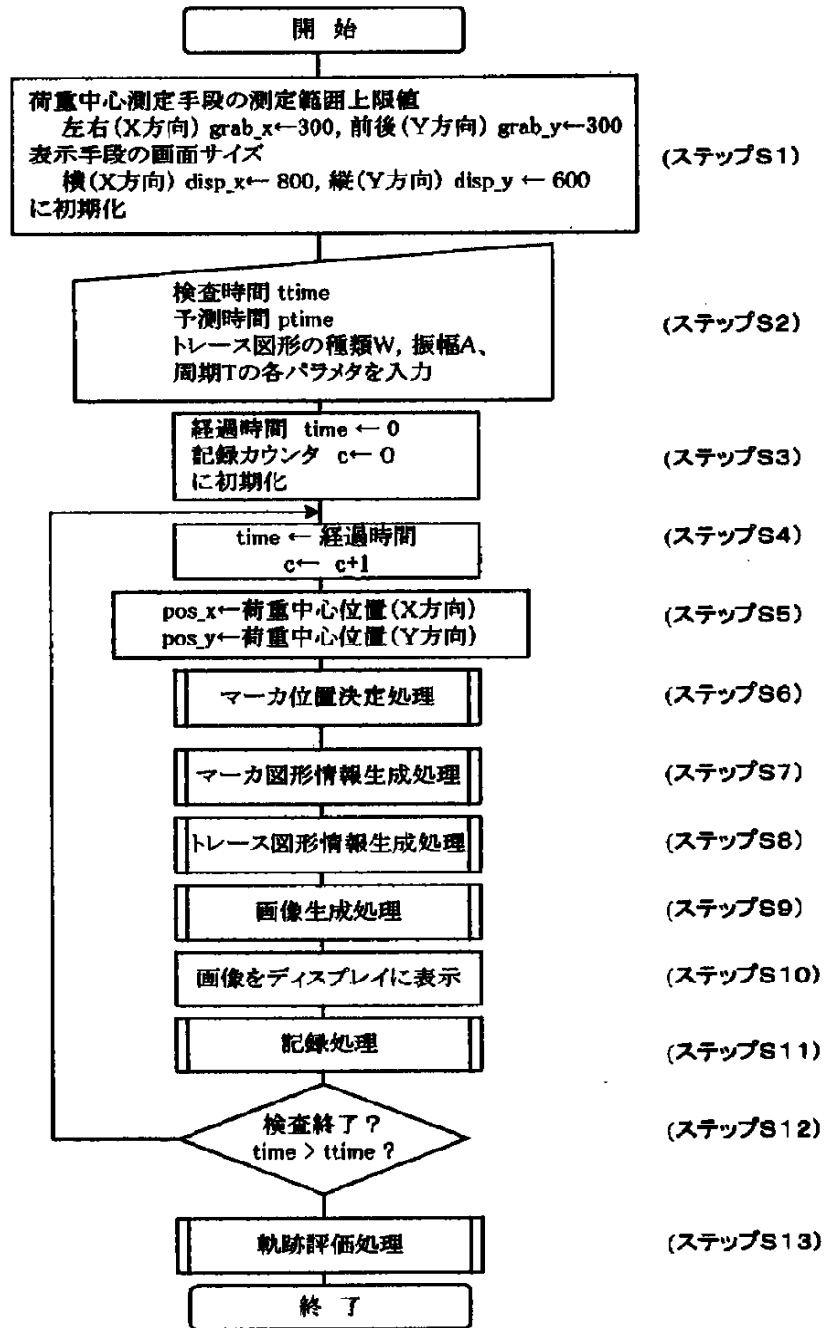

y } E

y } E

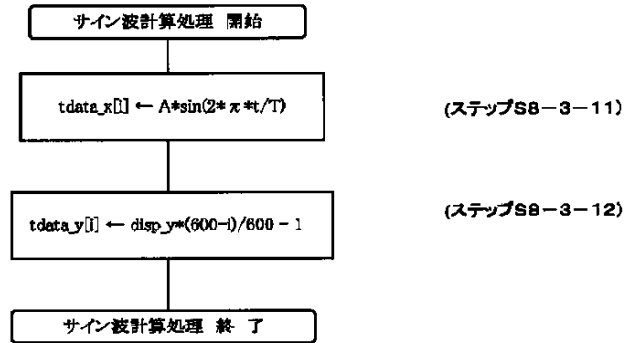
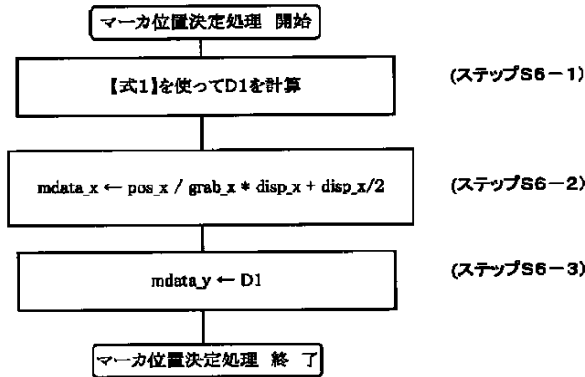

y } E

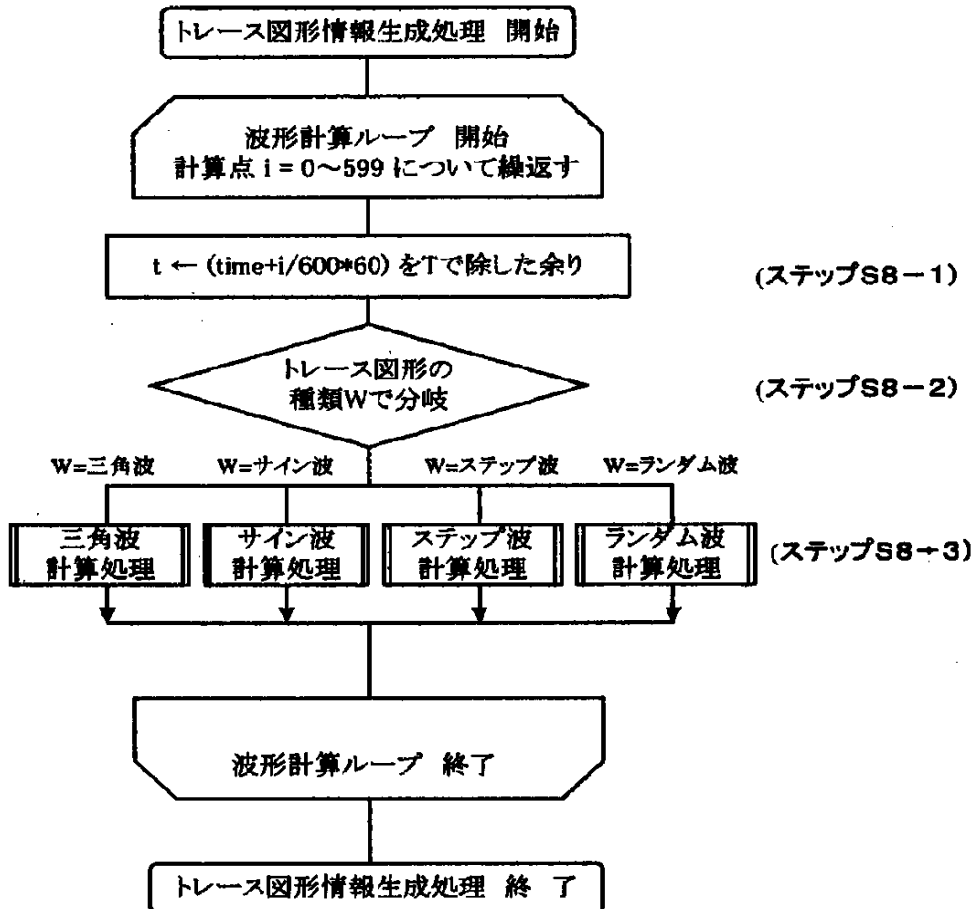

y } 〇

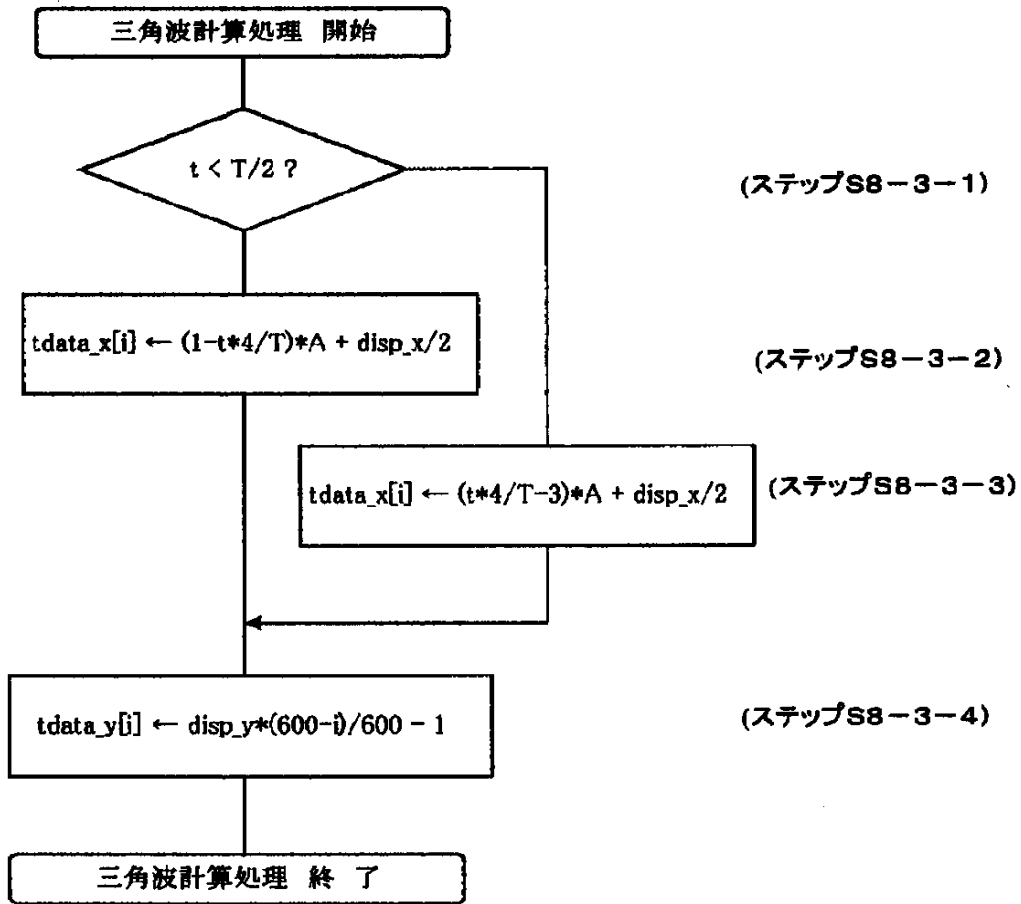

y } 〇

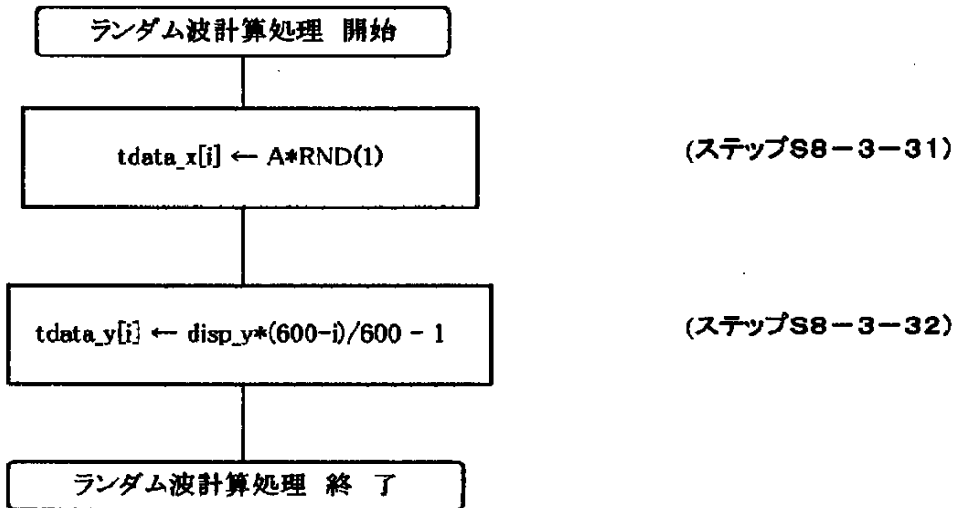

y } 0

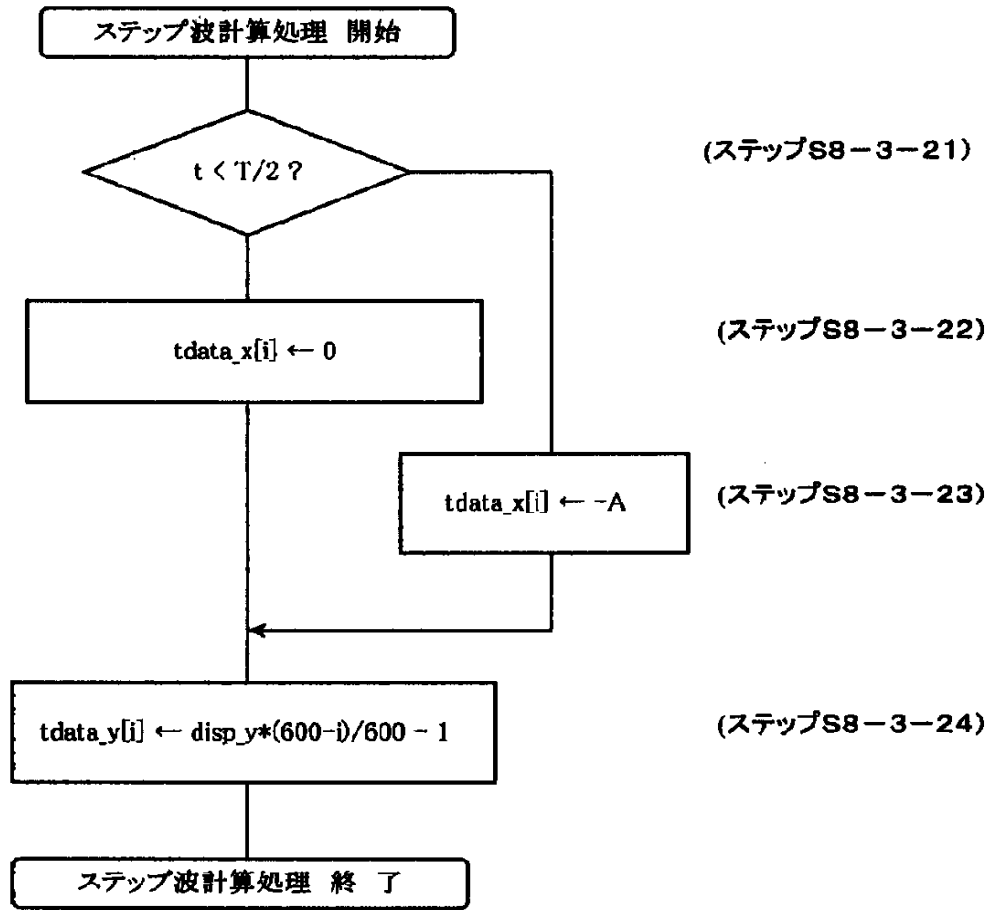

y } 0

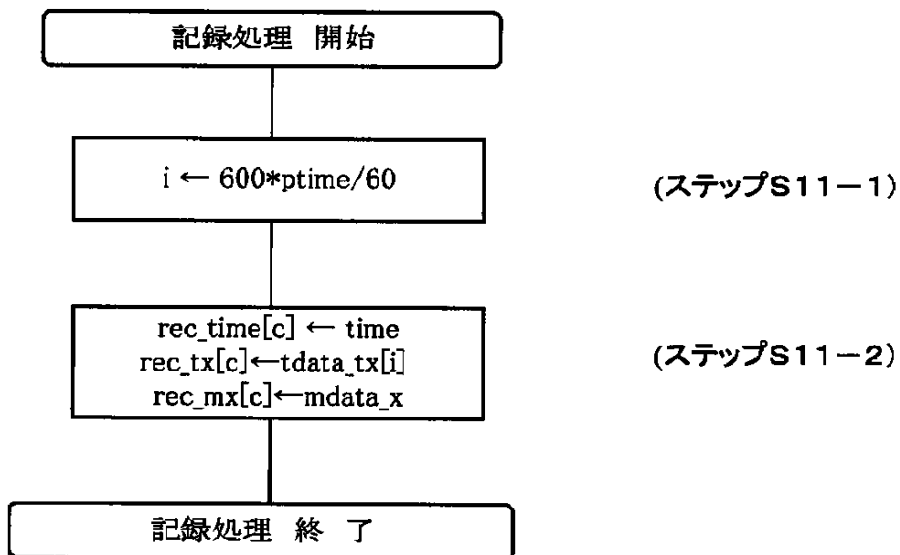

y } 0

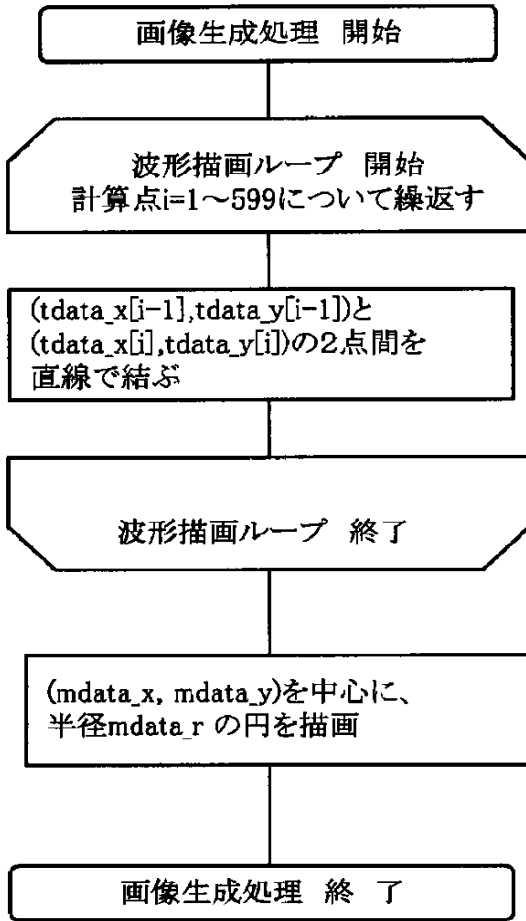

(ステップS9-1)

(ステップS9-2)

y } 0

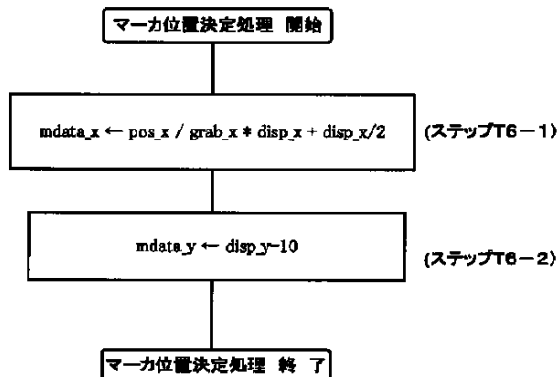

(ステップT6-1)

(ステップT6-2)

y } 0

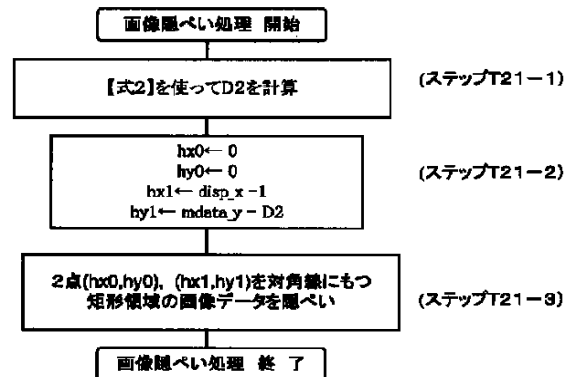

(ステップT21-1)

(ステップT21-2)

(ステップT21-3)



y } 0

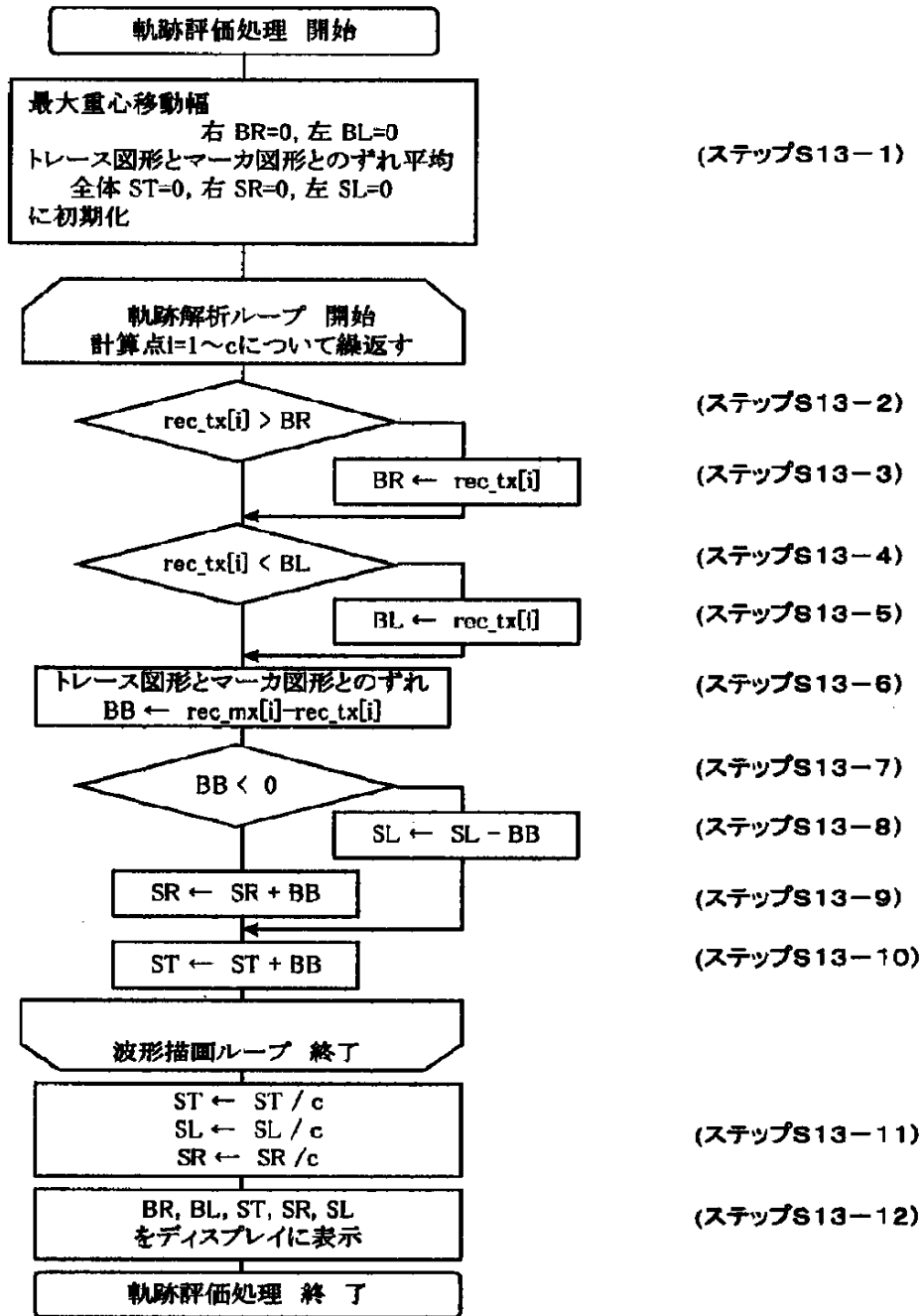

y } 要

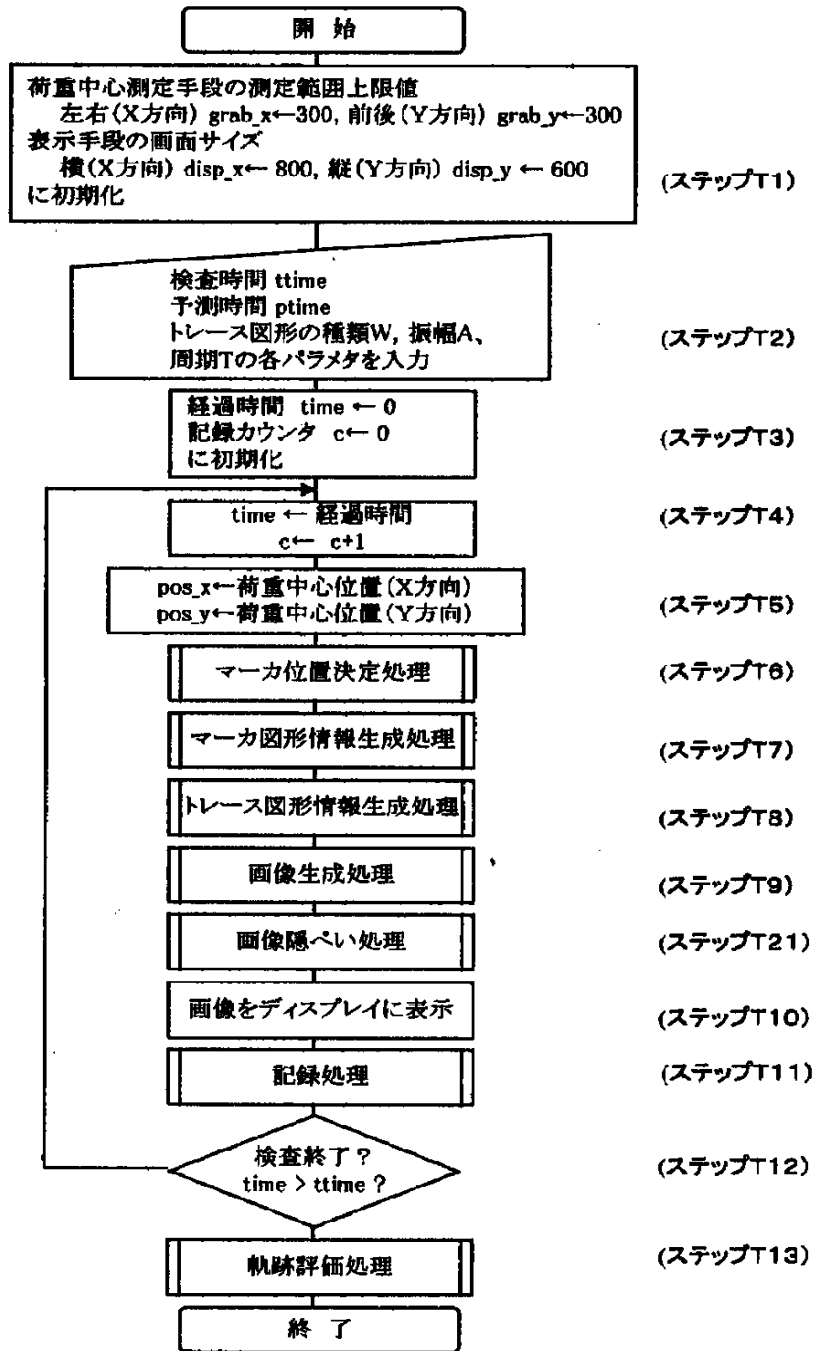

Y } 図

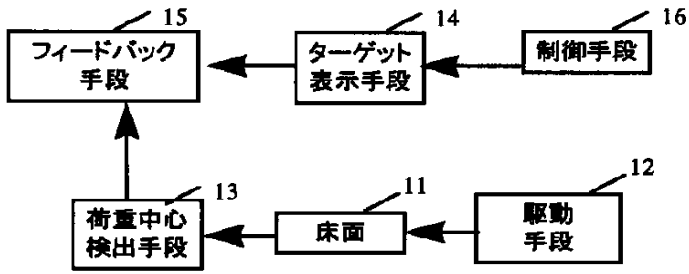

Y } 図

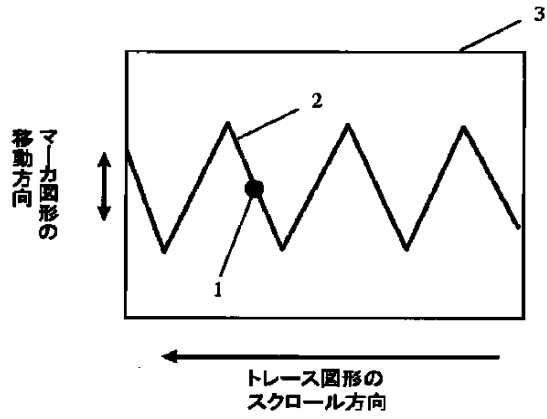

Y } 図

